

Accurate Time & Frequency system

GPS-Disciplined Rubidium Clock

With optional anti-spoofing and Jamming capabilities

The **AR/AS77** is a multi-function GPS Disciplined Rubidium Atomic Clock, which provides accurate time & frequency. The AR/AS77 incorporates numerous features into a single box, including a Rubidium Frequency Standard, an internal GPS C/A Code Receiver (which should be supplied by the customer) and an input from external 1PPS / frequency.

Key Features

- Frequency Accuracy: 1E-12
- 1PPS Accuracy: 20ns RMS
- Holdover: 1µs/24 hours, 1E-10/month
- Multiple outputs (10MHz, 1PPS, TOD)
- LAN (NTP V3, Monitor & Control – UDP&SNMP)
- External 1PPS / Frequency input for disciplining
- GPS C/A Code Receiver
- Front Panel Display (Time, Date, BIT and more)
- Monitor & control: RS232, UDP, SNMP
- Supply Voltage: 90/260 VAC
- Delay Correction for Input & Output
- Graphic User Interface (GUI) Software for PC
- Proprietary spoofing and jamming detection algorithm



Description

The AR/AS77 receives a GNSS (GPS) signal from the antenna and performs an integrity test on the signal using a local Rubidium clock and other proprietary methods. If the AR/AS77 determines that the GNSS signal is unreliable (due to jamming, spoofing or any other malicious attacking), it sends a warning alarm and use timing derived from the local Rubidium clock operating in “Holdover” mode. This action allows continuous and uninterrupted timing and synchronization signals even in a GNSS denied or spoofed environment.

The various options of the unit include a variety of different frequencies and several Time Codes outputs. The Rubidium Standard functions as a local oscillator and is phase-locked to the GPS or to external inputs. All outputs are derived from the Rubidium Clock, which maintains accurate time and frequency when GPS or other inputs are interrupted.

The unit includes up to three physical LAN interfaces boards, which support UDP / SNMP for management and for NTP (Network Time Protocol). The three LAN boards can be used for three different networks (with three different IP network addresses), or for two networks where the 3rd LAN board is reserved as a redundant back-up. A Precision-Time Protocol (PTP) is available with one of the LAN board.

The AR/AS77 provides multiple outputs: 10 coax outputs, two fixed (10MHz and 1PPS) and 8 configurable outputs which can be selected from 1PPS, 10MHz, and more.

Additional outputs are available on the D-Type connector including differential PTTI (ICD-GPS-060) outputs and Have Quick TOD (Time Of Day) protocol.

The unit is 19” x 1U rack-mountable encasement.

All specs are @ 25°C, quiescent conditions and sea level ambient unless otherwise specified

Basic Configuration		
Outputs	TNC Connectors	6 x Sine Wave (10±2 dBm) 3 x 1PPS (TTL/50Ω) 1 x Have Quick (ICD GPS 060)
	44 pins D Type Connector	4 x 1PPS (RS422) – Rubidium 1PPS 3 x 1PPS (RS422) – these outputs can be configure to be Rubidium backup 1PPS or raw 1PPS 5 x TOD ICD-GPS-060 -Have Quick 4 x 1PPS (ICD-GPS-060) H/W BIT (open collector)
Inputs	TNC Connector	<ul style="list-style-type: none"> Provision for Time / Frequency Disciplining: 1PPS (TTL/50Ω or ICD-GPS-060) or 10MHz Provision for TOD synchronizing: Have Quick (ICD GPS 060)
	Front panel	Crypto keys (Not used connector)
LAN	<ul style="list-style-type: none"> IPV4 NTP server V3 per RFC1305 ≤ 1ms, each LAN board can support up to 1100 NTP requests per second DHCP Control & Monitoring (UDP) 	<ul style="list-style-type: none"> IEEE 1588 / PTP – Grandmaster / slave (one output) Up to 3 independent LAN ports (3 NTP servers or 2 NTP servers and one PTP) Each one has a different IP address serving three separates networks SNMP V3 (Custom MIB)
CLI	RS-232 port remote control	

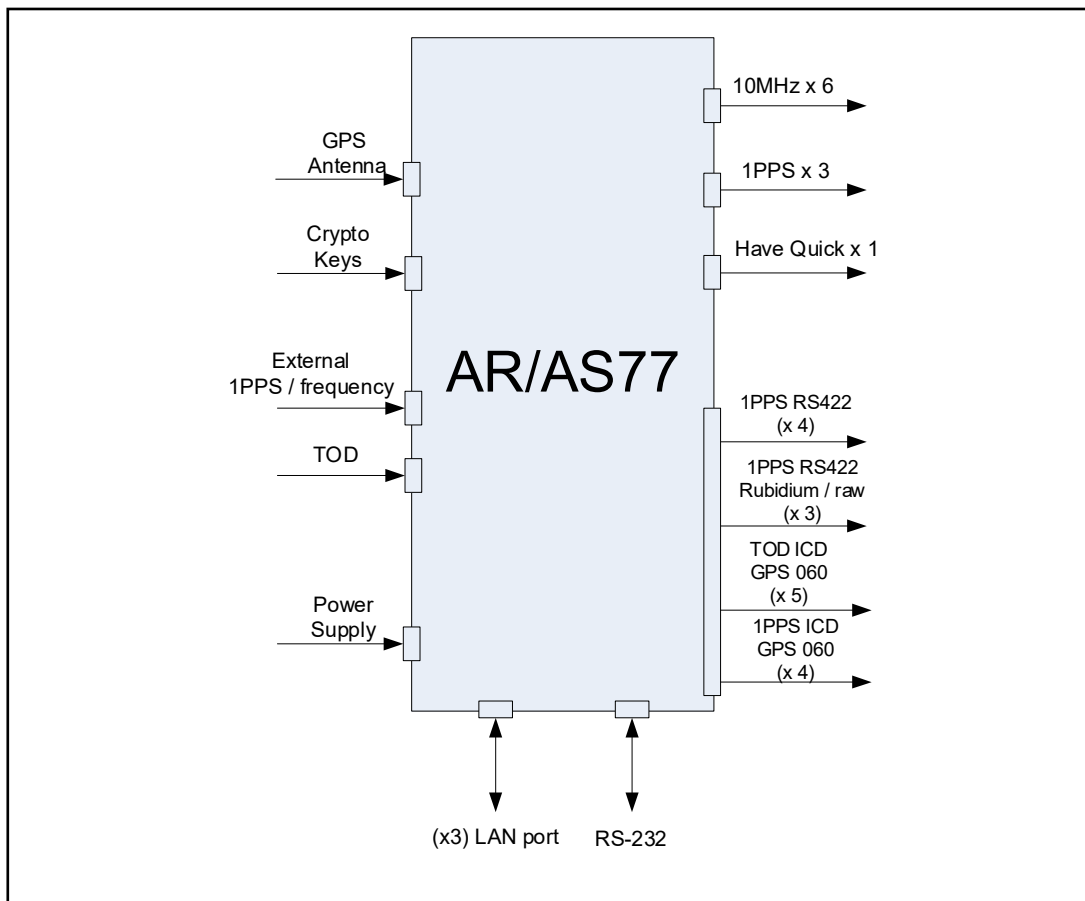

All specs are @ 25°C, quiescent conditions and sea level ambient unless otherwise specified

Performance		
Mode of work	Disciplined to GPS or to external 1PPS	Free running Rubidium
Time (1PPS)	20ns RMS relative input	1 μ s/ 24 hours (typical) After 24 hours of disciplining @ 25°C
Frequency	Frequency Accuracy	$\leq 1E-12$
	Long Term Stability	$\leq 1E-10$ / month
	Short Term Stability (ADEV)	3E-11 @ 1s 5E-12 @ 100s
	Temperature Stability	$\pm 3E-10$ over -20°C to +65°C
	Phase Noise (*) (@ 10MHz)	≤ -113 dBc/Hz @ 10Hz ≤ -140 dBc/Hz @ 100Hz ≤ -144 dBc/Hz @ 1KHz ≤ -147 dBc/Hz @ 10KHz
	Harmonics (*) (10MHz)	≤ -48 dBc
	Spurious (*) (10MHz)	≤ -100 dBc @ ± 100 KHz
	Warm-up time	Rubidium Lock < 4 minutes 5E-11 within < 60 minutes 1E-11 within < 4 hrs 1E-12 within < 24 hrs

(*) The above figures are given for the J17 output. Some degradation may occur for other outputs.

All specs are @ 25°C, quiescent conditions and sea level ambient unless otherwise specified

GPS C/A Code Receiver	
GPS Tracking	L1 frequency 1575 MHz C/A code (SPS), 12 parallel tracking channels
Ephemeris & Almanac	Available on 44 pin D Type connector (option)
Position Accuracy	Latitude, Longitude: < 6m (CEP 50%), Altitude: < 11m (CEP 50%)
GPS signal gain at antenna input (*)	23dB-35dB
GPS Antenna DC Voltage	5VDC (up to 100 mA)

Environmental	
Operating Temperature	-20°C to +65 °C
Storage Temperature	-20°C to +70°C
Humidity	15 – 85 % @ 40°C (non condensing) under operation
Temperature Altitude	Operating: -10°C to +45°C @ 10k feet Non operating: -40°C to +71°C @ 40k feet
Transportation Vibration	MIL-STD-810E Method 514.4 Category 1 (basic transportation), figures 514.4-7 to 514.4-9 1.04g RMS, 60 minutes (for each axis)
Functional vibration	RTCA DO-160E, Section 8, figure 8-1, Curve B2 (0.74 gRMS) (The vibration can cause some degradation on the phase noise)
Robust vibration	RTCA DO-160E, Section 8, figure 8-4, Curve B12 (1.48 gRMS)
Operational Shock	Total 18 shocks, three (3) shocks in both directions of the three orthogonal axes 11 ms, half sine, 6g
Crash safety shock	Saw tooth, 20g, 11 ms (for each axis). Total shocks: 18 shocks.
Structural acceleration	Up to 9 g
Fungus	MIL-HDBK-454B

Power Supply	
Power Supply	28VDC± 4V
Power Consumption	< 37W Warm-up , < 25W Steady state

All specs are @ 25°C, quiescent conditions and sea level ambient unless otherwise specified

Front panel display & indications and GUI	
Display	The LCD front panel display and buttons enable the user to view and configure most parameters. The displayed information includes the Time, Date, BIT, GPS parameters (antenna current, satellite status) and more. Configured parameters include time synchronizations source, 1PPS delay, outputs configuration and more. For details see user manual or contact factory. Florescent display is available as an option (instead of the LCD display).
LED Indications	4 LEDs on the front panel: Power, Overall BOT, TOD Source, 1PPS / FREQ Source
Graphic User Interface (GUI) – option (The GUI is software for PC used for maintenance and as a starter kit)	<ul style="list-style-type: none"> ○ Time / date display ○ Satellites in view ○ Navigation data from GPS and ○ BIT (Built In Test) ○ Time source & Time zone ○ Leap seconds (from UTC to GPS) ○ IP address configuration ○ Antenna cable delay ○ External input and 1PPS output delay ○ Matrix configuration ○ Time setting GPS / UTC ○ Additional parameters

Principles of Operation

The following block diagram describes the operation of the AR/AS77. The unit includes Rubidium Clock and accepts inputs from either internal GPS receiver or external 1PPS & TOD sources. All outputs are derived from the internal Rubidium Clock, which is phase-locked via a digital PLL to the internal GPS receiver or to one of the external inputs. This way, the Rubidium Clock follows the GPS long term accuracy and cleans the jitter and the noise on the short and medium terms. When the GPS reception is lost, for short or long periods of time, the Rubidium continues to maintain accurate time and frequency.

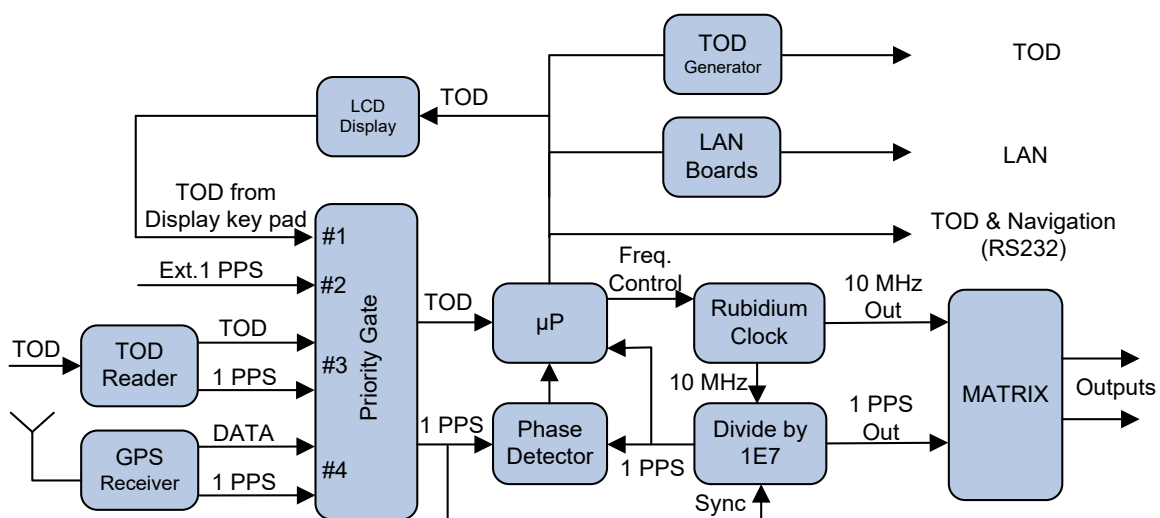

All specs are @ 25°C, quiescent conditions and sea level ambient unless otherwise specified

Precision Time Protocol – PTP (option)

- IEEE-1588-2008 V2 PTP Grandmaster/Slave
- Multicast / Unicast modes of operation
- UDP/IPv4 (L2 or L3)
- Design to handle up to 200 slaves simultaneously
- Accuracy: $\leq 1\mu\text{s}$ (network dependency)

In the following figure, two AR/AS77 units are interconnected via a network (one as a master and one as a slave). The time interval between the two 1PPS outputs was measured over time and the results are shown in the plot below.

PTP performance measurement setup

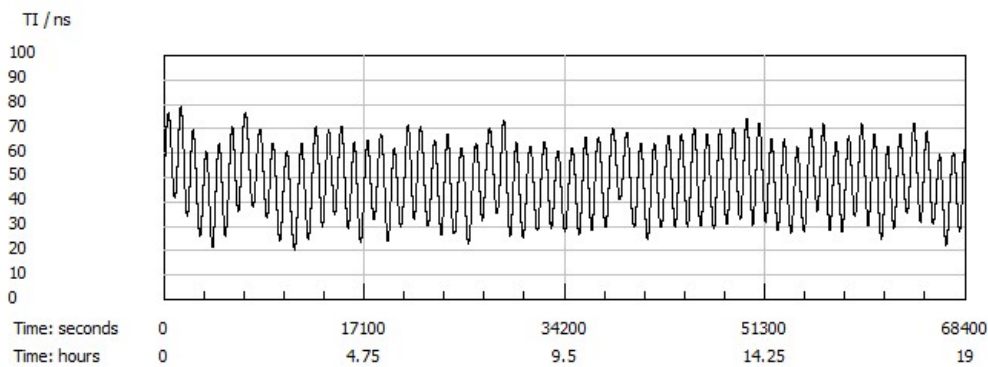
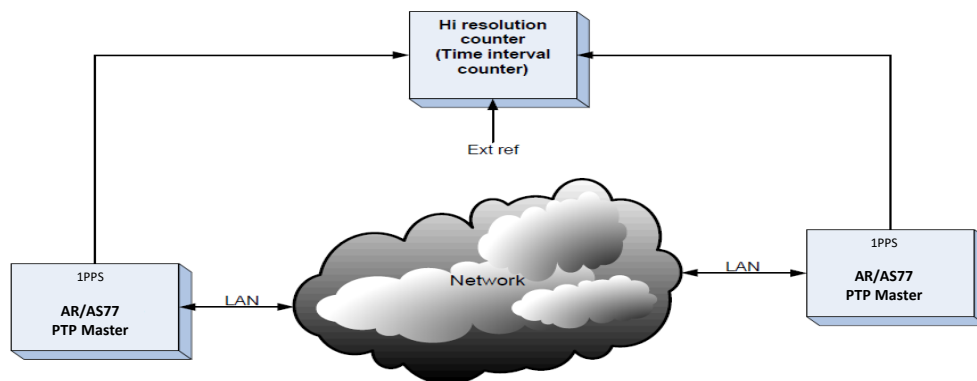

Time accuracy < 50ns RMS

(measured on low traffic, symmetrical path network and low number of users)

All specs are @ 25°C, quiescent conditions and sea level ambient unless otherwise specified

Electrical ICD		
Connector	Description	Standard Type
J1	Power supply	28VDC
J2	GPS antenna	TNC, Female
J4	LAN	RJ-45
J6	CLI	D9, Female
J7	Additional I/O	D type, 44 pin, Female
J8 – J17	Coax outputs	TNC, Female
J18 - J19	Inputs	TNC, Female
Front panel	Crypto keys	Audio connector jack, 5 pins (Not used connector)

J6 – RS-232 communication to PC - 9 pin D type connector signals:

Pin Number	Function
2	CLI-Tx (to PC)
3	CLI-Rx (from PC)
5	GND
1, 4, 6, 7, 8	Factory use
9	COM from CLDU / CDU

RS-232, 19,200 baud rate, 1,8,1 no parity (default)

J7 – Auxiliary Time, Frequency, communication and miscellaneous - 44 pin D type connector signals:

Pin Number	Function	Pin Number	Function
1	FACTORY USE	23	GND
2	FACTORY USE	24	FACTORY USE (Lock signal)
3	1PPS_RS422_OUT+ (#1) (*)	25	GND
4	1PPS_RS422_OUT- (#1) (*)	26	TOD (H.Q.)_PTTI output (#1)
5	GND	27	TOD (H.Q.)_PTTI output (#2)
6	1PPS_RS422+ output (#1)	28	TOD (H.Q.)_PTTI output (#3)
7	1PPS_RS422- output (#1)	29	TOD (H.Q.)_PTTI output (#4)
8	1PPS_RS422+ output (#2)	30	TOD (H.Q.)_PTTI output (#5)
9	1PPS_RS422- output (#2)	31	GND
10	1PPS_RS422+ output (#3)	32	1PPS_PTTI output (#1)
11	1PPS_RS422- output (#3)	33	1PPS_PTTI output (#2)
12	1PPS_RS422+ output (#4)	34	1PPS_PTTI output (#3)
13	1PPS_RS422- output (#4)	35	1PPS_PTTI output (#4)
14	GND	36	Over all BIT (open collector) The maximum current through the open collector is 100mA. When the Overall BIT is OK, the output level is low.
15	5.5V (internal 300Ω series resistor)	37	GND
16	1PPS_RS422_OUT+ (#2) (*)	38	FACTORY USE
17	1PPS_RS422_OUT- (#2) (*)	39	FACTORY USE
18	1PPS_RS422_OUT+ (#3) (*)	40	FACTORY USE
19	1PPS_RS422_OUT- (#3) (*)	41	FACTORY USE
20	GND	42	FACTORY USE
21	FACTORY USE	43	FACTORY USE
22	FACTORY USE	44	FACTORY USE

All specs are @ 25°C, quiescent conditions and sea level ambient unless otherwise specified

AR/AS77 - Mechanical ICD

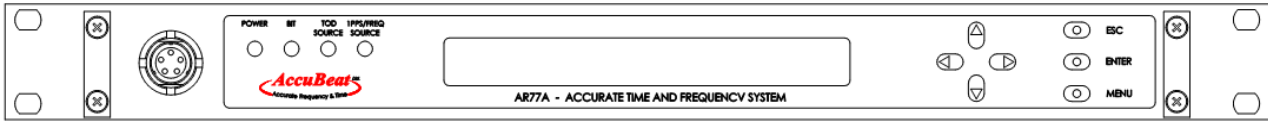

Front panel

Dimensions: 19" (482.6 mm), 1U (43.7mm)

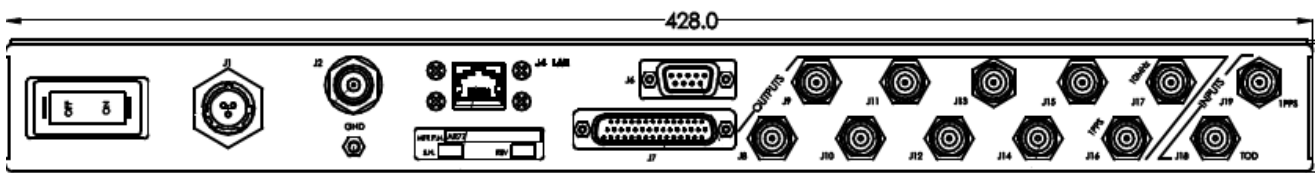

Rear panel for 1 LAN with DC input

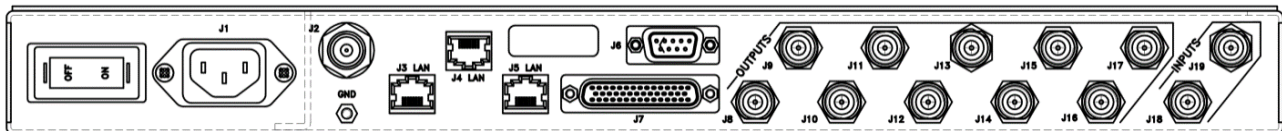

Rear panel for 2 or 3 LANs with AC input

Weight: $\leq 3/5$ kg

HOW TO ORDER

AccuBeat recommends the following operation configuration:

1. Time & Sync. source : GPS (See 'STS' & 'SPS' CLI commands).
2. AccuBeat GPS anti-spoofing suit ("Narrow Bell").
3. AccuBeat calibration suitcase for GPS denied environment.

For other operation configurations please contact factory in order to verify proper operation.

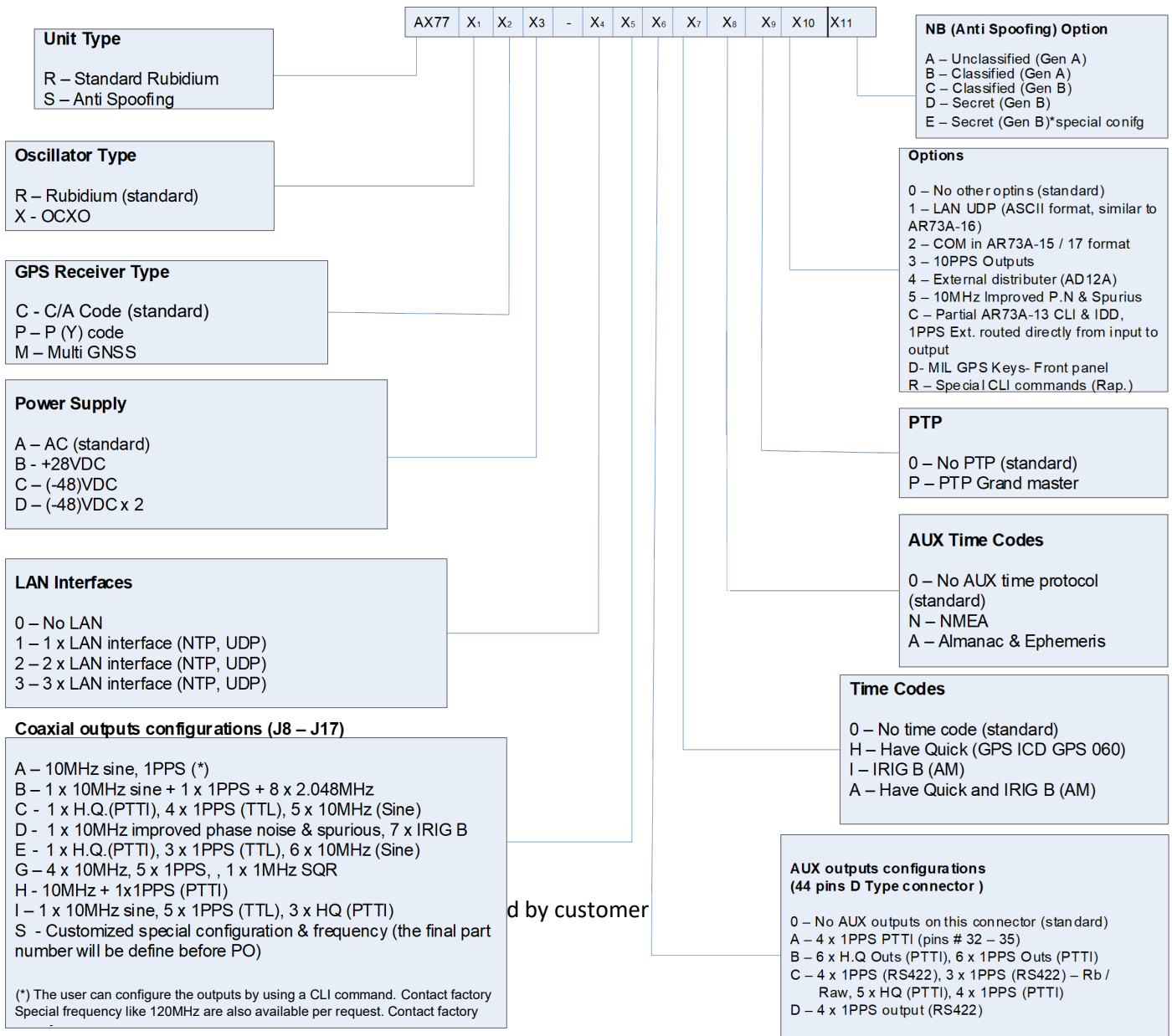

AccuBeat Ltd, 5 Ha'Marpeh St., Har Hotzvim, P.O.Box 45012, Jerusalem 91450, Israel
Tel: +972-2-5868330, Fax: +972-2-5868550, E-Mail: marketing@accubeat.com
<http://www.accubeat.com>